

65868

FULL THROTTLE SUSPENSION

2014-2015 Dodge 2500 4wd 8" Radius Arm Kit W/ Front Coil Springs



65868

2014-2015 Dodge 2500 4wd 8" Radius Arm Kit W/ Front Coil Springs

66858-6 Component Box 1

- 1) 8" Left Radius Arm
- 1) 8" Right Radius Arm
- 1) Track Bar Drop Bracket
- 1) Left Sway Bar Drops
- 1) Right Sway Bar Drops
- 1) Drop Pitman Arm

Hardware Bag 1

- 3) 1/2 X 1 1/2 Bolts
- 3) 1/2 Nut Inserts
- 3) 1/2 Washers
- 1) 18mm X 90mm Bolts
- 1) 18mm Nylock Nuts
- 2) 18mm Washers
- 5) 7/16 X 1 1/4" Bolt
- 5) 7/16" Nylock Nut
- 9) 7/16" Washers
- 1) 7/16" Large Dia. Washer

Hardware Bag 2

- 1) Left Brake Line Bracket
- 1) Right Brake Line Bracket
- 2) 5/16" X 1" Bolts
- 2) 5/16" Nylock Nuts
- 4) 5/16" Washers

65864-7 Component Box 1

- 1) Transmission Cross Member

66865-10 8" Coil Springs

- 2) 8" Front Coil Springs

D11-850 Front Drive Shaft Spacer

- 1) Front Drive Line Spacer D11-850
- 4) 7/16 X 3.25 BOLTS

W/ 68RFE Transmission

64000-9 Reclocking Ring

- 1) 10.4 Degree Reclocking Ring
- 6) 10mm X 25 Mm Allen Bolts
- 6) 3/8 Studs
- 6) 3/8 Fine Nuts

W/ Aisin Transmission

65830-11 Reclocking Ring

- 1) Reclocking Ring 11 Degree
- 8) 10 x 25 Mm Allen Bolts
- 8) 3/8" Studs
- 1) Seal Adaptor
- 1) Seal

65864-2 Component Box 2

- 1) 5 1/2" Track Bar Bracket
- 1) 5 1/2" Driver Side Coil Spacers
- 1) 5 1/2" Passenger Side Coil Spacers
- 2) 5 1/2" Rear Bump Stops
- 2) 5 1/2" Sway Bar Drop Bracket
- 2) Lower Trailing Arms 24"

Hardware

- 1) S2842 Sleeve .565 x 1.0 x 2.150
- 1) 9/16" x 4 1/2" Bolt
- 1) 9/16" Nylock Nut
- 2) 9/16" Washers
- 2) 1/2" x 1 1/2" Bolts
- 2) 1/2" Nylock Nuts
- 4) 1/2" Washers
- 9) 7/16 x 1 1/4" Bolt
- 1) 7/16 x 1 1/2" Bolt
- 10) 7/16" Nylock Nut
- 20) 7/16" Washers
- 6) 3/8" x 1" Bolts
- 6) 3/8" Nylock
- 12) 3/8" Washers

Hardware

- 8) MO2918 Bushings
- 4) S3961 Sleeves .830 ID x 1.0" OD x 3.575 Length

1) Disconnect the negative terminal on the battery. Jack up the front end of the truck and support the frame rails with jack stands. **NEVER WORK UNDER AN UNSUPPORTED VEHICLE!** Remove the front tires.

2) Support the front axle with 2 floor jacks.

3) Remove the bolts attaching the brake line tabs to the front axle.



4) Remove the front sway bar end links from the axle mount. Remove the bolts securing the sway bar mounts to the frame and set the sway bar aside, save all sway bar hardware. **NOTE** the orientation of the sway bar for installation.

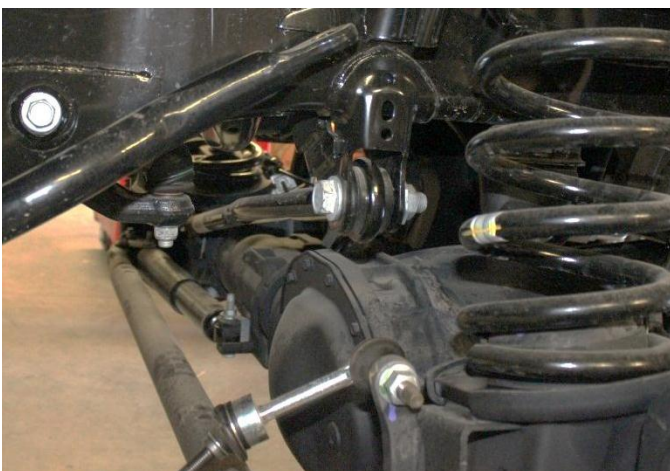
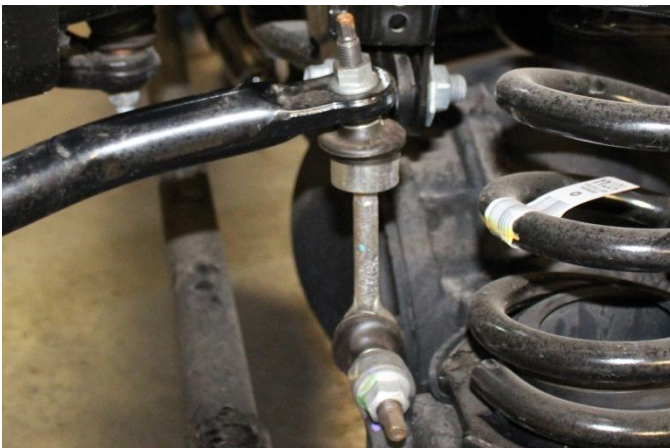

5) Disconnect the front 4wd actuator from the axle housing.

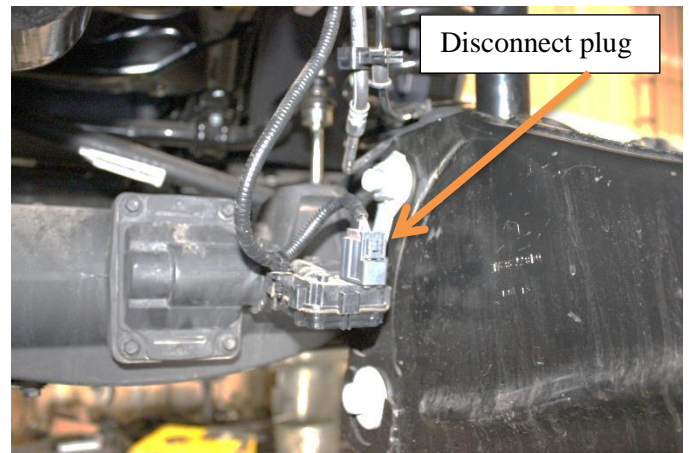

6) Remove bolt holding the drive shaft to the front differential.



7) Disconnect the ABS wiring.

8) Using a crescent wrench loosen the jam nuts on the drag link.



9) Remove the hardware attaching the drag link to the pitman arm. Save the hardware.



10) Using a hammer, strike the pitman arm to dislodge the tie rod from the pitman arm.



11) Unscrew the tie rod end out of the coupler.



12) Using a die grinder or abrasive saw remove the flat portion of the tie rod.



13) Remove the nut securing the track bar to the frame and separate. Save the track bar hardware.

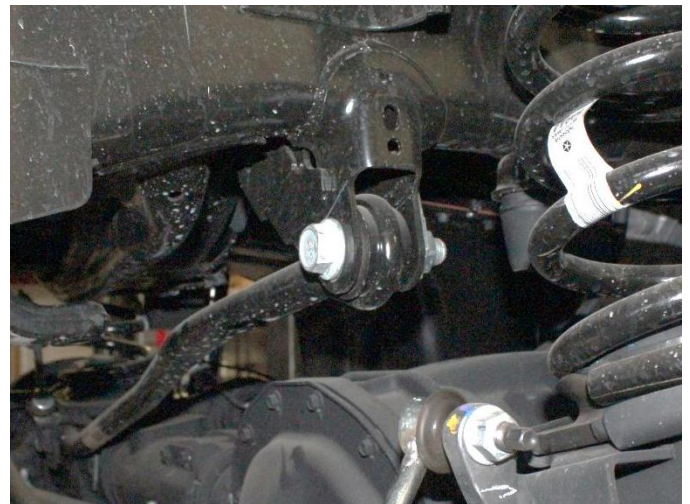

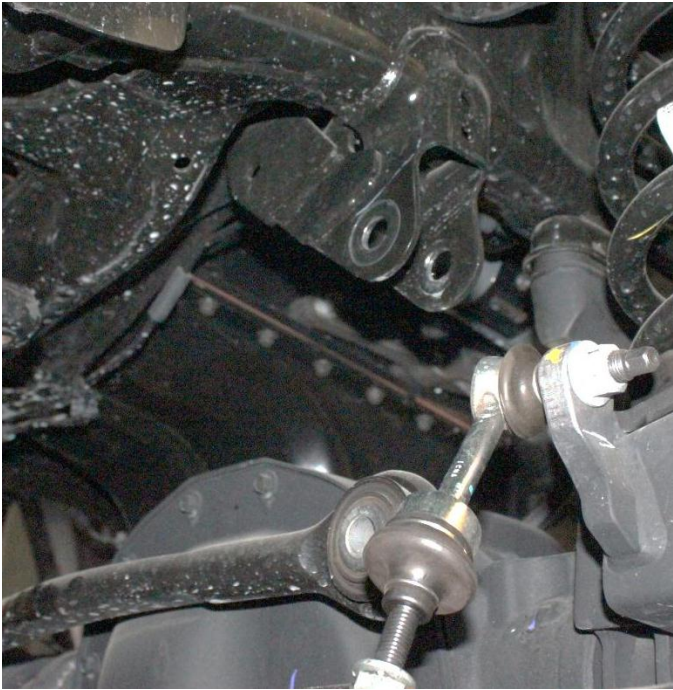

14) Remove the front upper nut and the lower bolts securing the shock to the axle. Save the lower Hardware. Remove shocks.



15) Leaving the front axle supported on the 2 jacks raise the truck enough to remove the coil springs. Save the upper rubber insulator & shocks for Reassembly. USE EXTREME CARE WHEN WORKING WITH COILS THAT ARE UNDER LOAD!

Skid step 16 if Installing FTS 2.0" shock

16) Install front shock extenders.



17) Install the shocks back into the truck to allow the front axle to hang from.



18) Loosen the bolts securing the link arms to the front axle and frame .



19) Remove the bolts attaching the link arms to the axle and frame.



20) Using a paint pin, mark the bushing as shown below.



21) Using a die grinder, cut along the line as shown below.



22) Using a press remove the bushing. Careful not to damage the bushing.



23) Install the bushing from the factory radius arm into the FTS radius arm as shown below.



24) Using a press, press the bushing into the arm



25) Install the FTS radius arm using the factory hardware.



26) Install the track bar bracket as shown, Use the factory hardware thru the factory hole in the frame. Snug the bolt enough to hold the bracket in place. Mark the 3 holes on the bottom side of the frame using the track bar bracket as a guide.

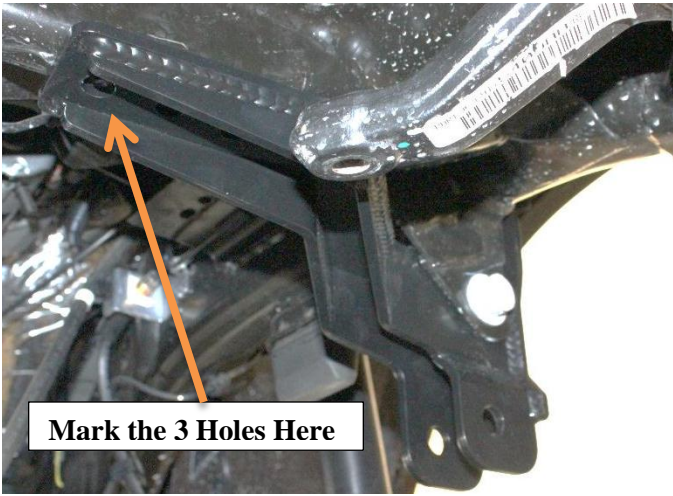

27) Remove bracket and drill hole to 11/16". Install the nutserts as shown.

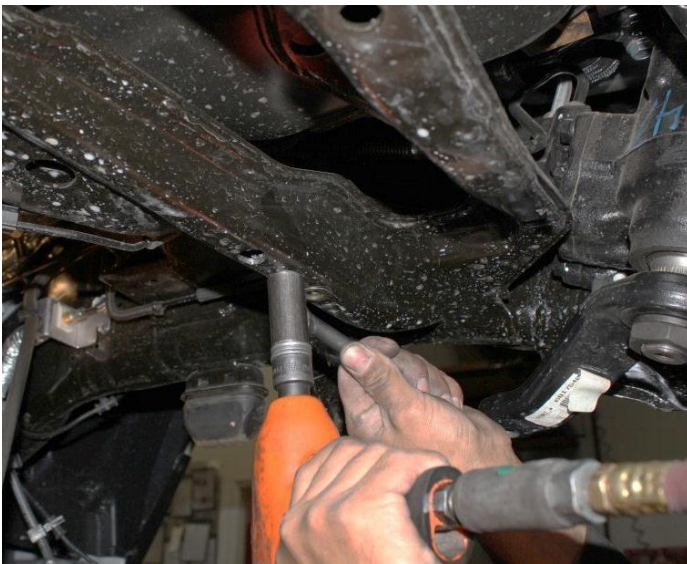

28) Remove the factory pitman arm and discard. Keep hardware.



32) Install the FTS drop pitman arm using the factory nut and lock washer plus thread locker. Torque to 220ft-lbs.



33) Reinstall the track bar bracket using the factory hardware.

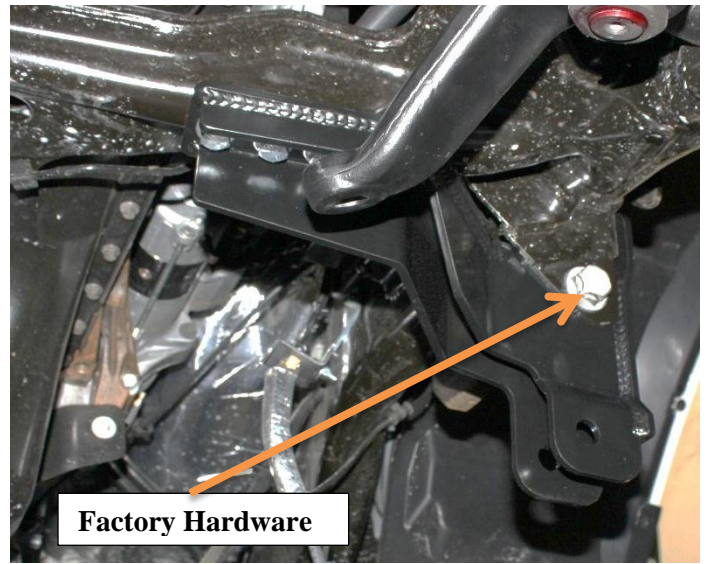

31) Install the 3 supplied 1/2" x 1 1/2" bolts as shown below.

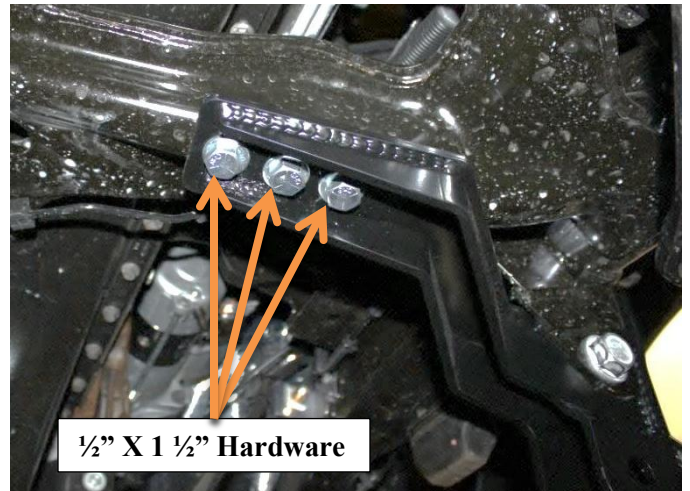

32) Install the nut tab from the bottom side of the track bar drop.

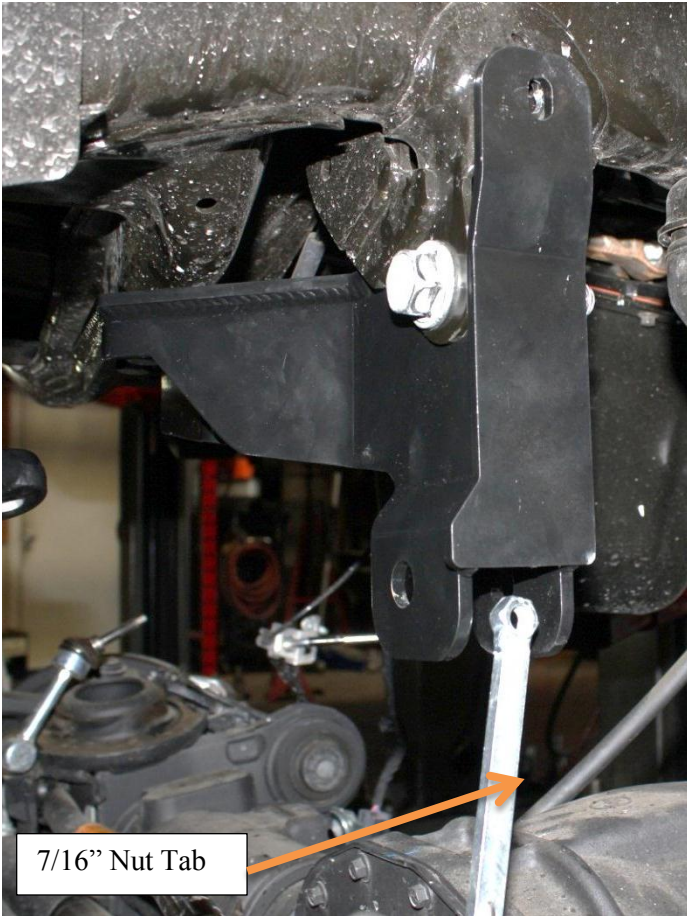

33) Install the 7/16" x 1 1/4" hardware as shown.

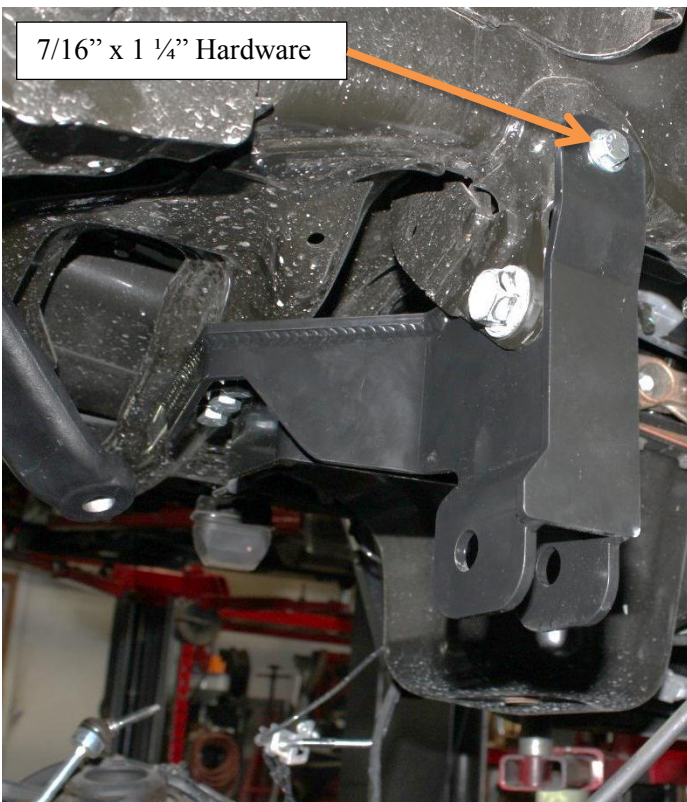

34) With the front axle supported on the jack stand, Remove the front shocks. Raise the vehicle enough to install the FTS coil springs as shown below. When installing the coil spring make sure to reinstall the factory insulator as shown.



35) Re-attach the upper and lower Shock Hardware.



36) Install the sway bar brackets as shown using the factory hardware attaching the bracket to the frame.

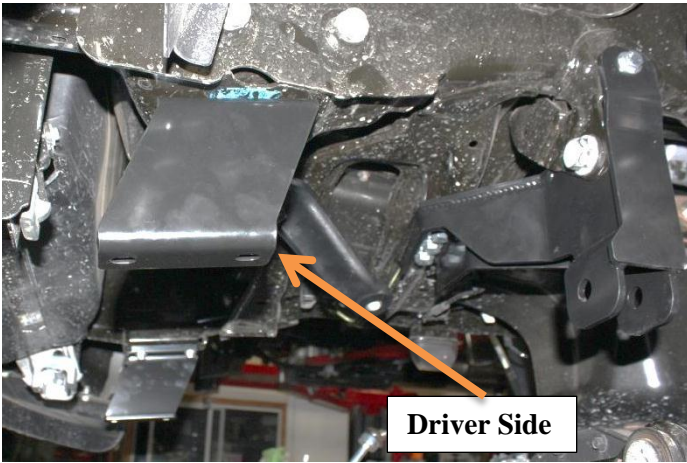

37) Use the 7/16" x 1 1/4" hardware to attach the sway bar to the drop brackets.

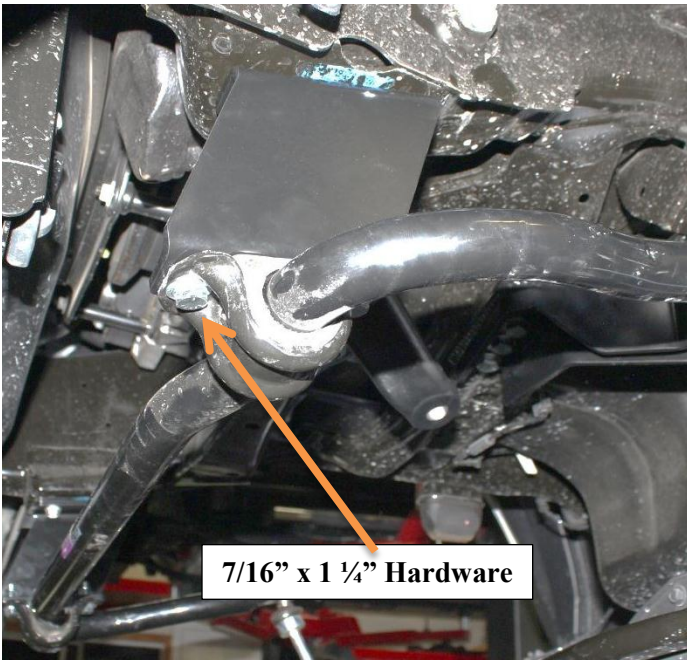

38) Reconnect the sway bar end link to the axle using the factory hardware.



39) Install the steering drag link into the pitman arm from the bottom side.



40) Re-attach the track bar to the track bar drop using the 18mm x 90mm Hardware.

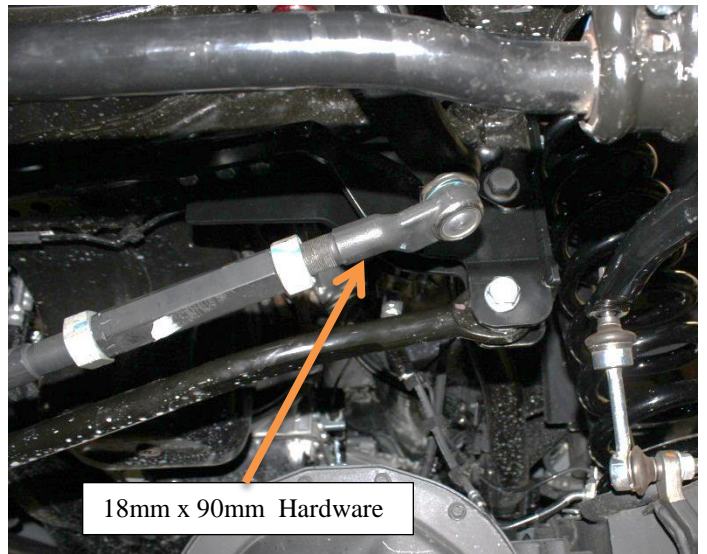

41) Install the supplied DRIVER upper brake line drop bracket using the factory hardware to attach the bracket to the frame and the supplied 5/16" x 1 hardware to attach the bracket to the brake line hardline bracket.

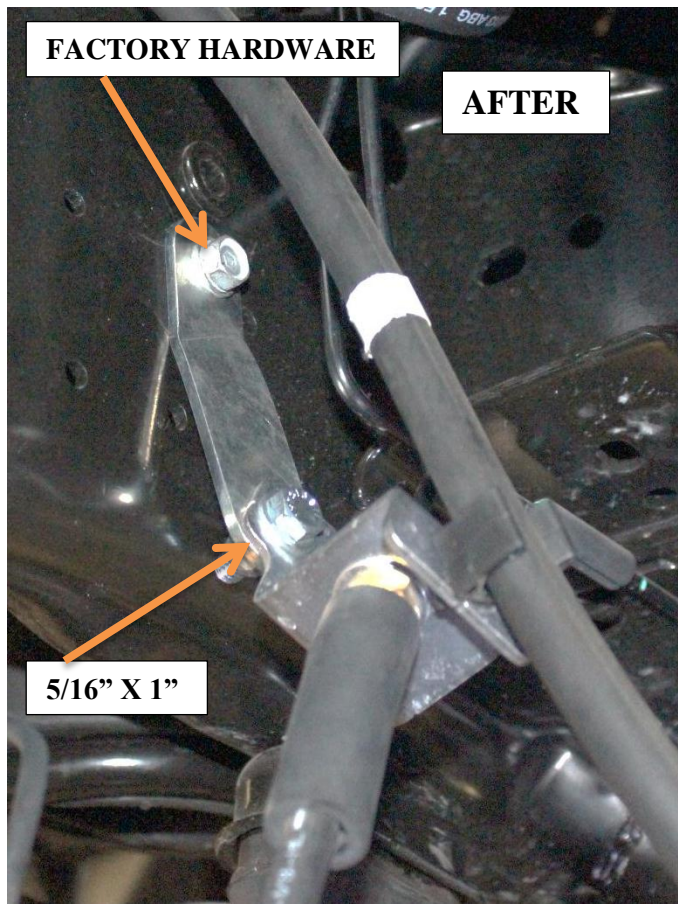
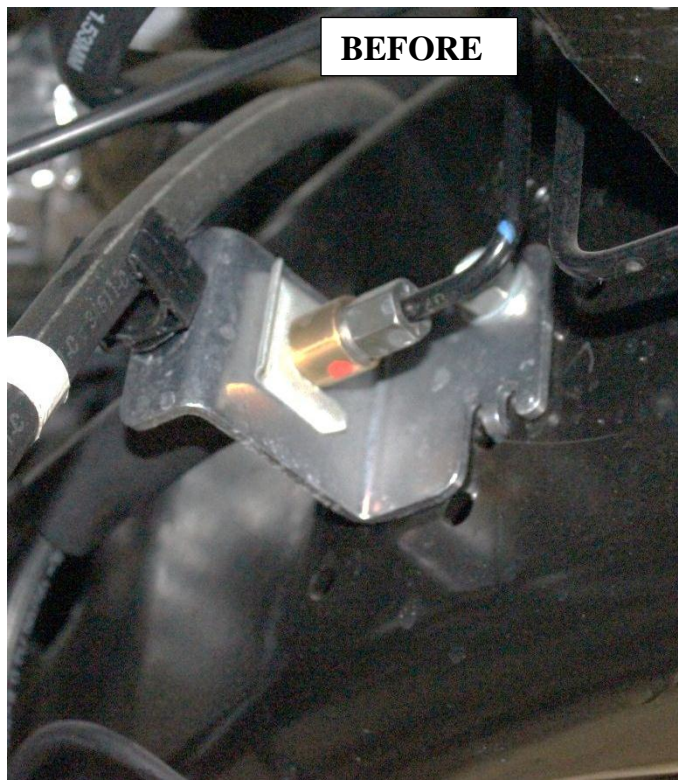

42) Install the supplied PASSENGER upper brake line drop bracket using 5/16" x 1 hardware to attach the bracket to the frame and the supplied 5/16" x 1 hardware to attach the bracket to the brake line hardline bracket.

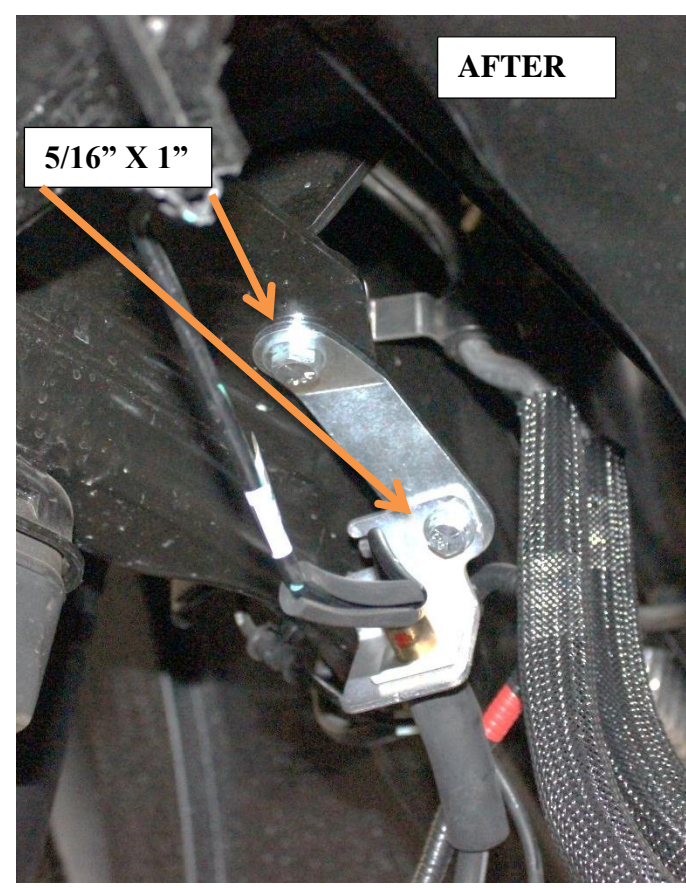

43) Using a crescent wrench, tight the jam nuts on the steering drag link as shown below.



44) Install front wheel and tires.

45) Reclock transfer case. See instruction part # below.

68RFE Transmission See Instruction # 64000-18

AISIN Transmission See Instruction # 65836-11

REAR INSTRUCTIONS:

- 1) Jack up the rear end of the vehicle and support the frame.
- 2) Remove the rear wheels.
- 3) Support the rear axle with a hydraulic jack.
- 4) Disconnect the rear brake line bracket from the axle, retain all hardware.

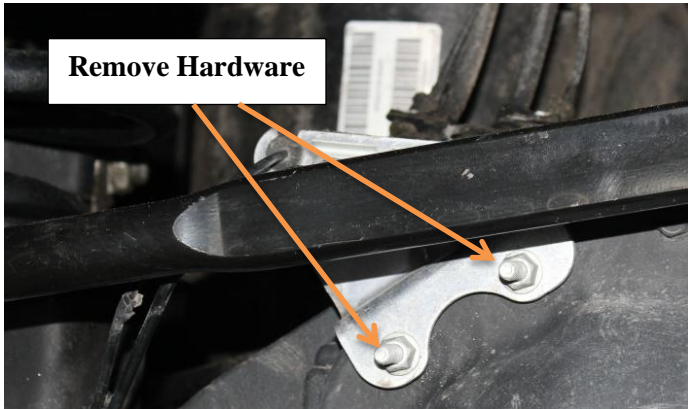

- 6) Disconnect the rear track bar from the axle, retain all hardware.



- 5) Disconnect the rear sway bar end links front the frame, retain all hardware.

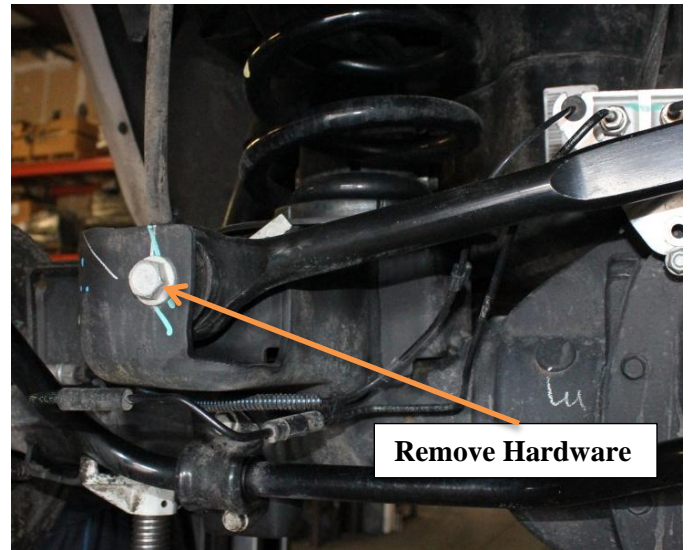

- 8) Disconnect the rear shocks lower shock hardware.

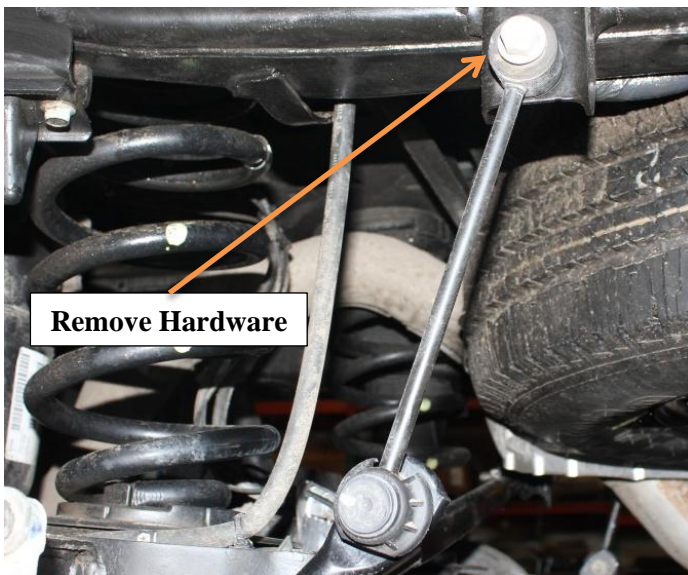

9) Disconnect the rear shocks upper shock hardware.

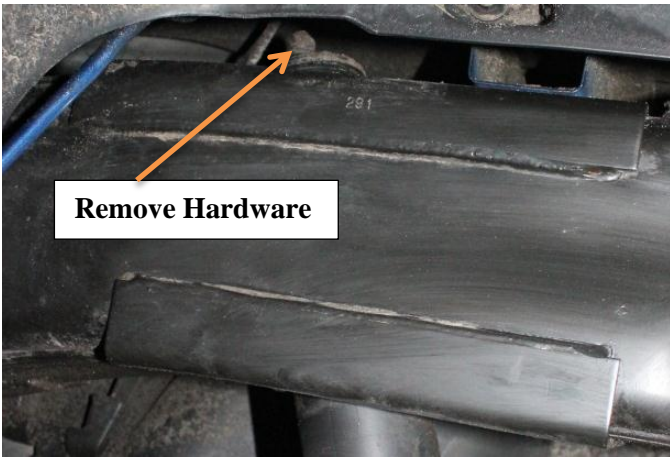

10) Lower the rear axle slowly, Remove the rear coil springs and upper and lower coil spring retainers.



11) Install the rear sway bar end link drop brackets using the supplied hardware.

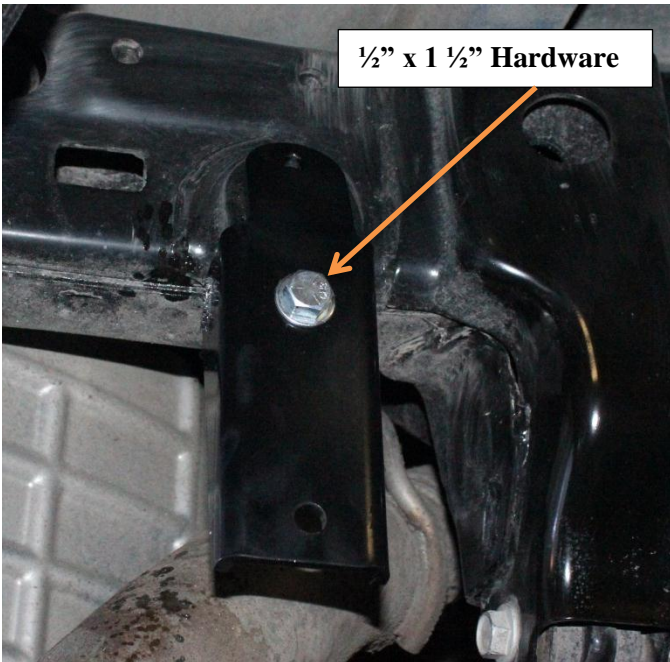

12) Drill the side hole in the frame 3/8". Use the sway bar drop bracket as the guide. Drill all the way through both sides.



13) Install the 3/8 x 1" hardware as shown below.

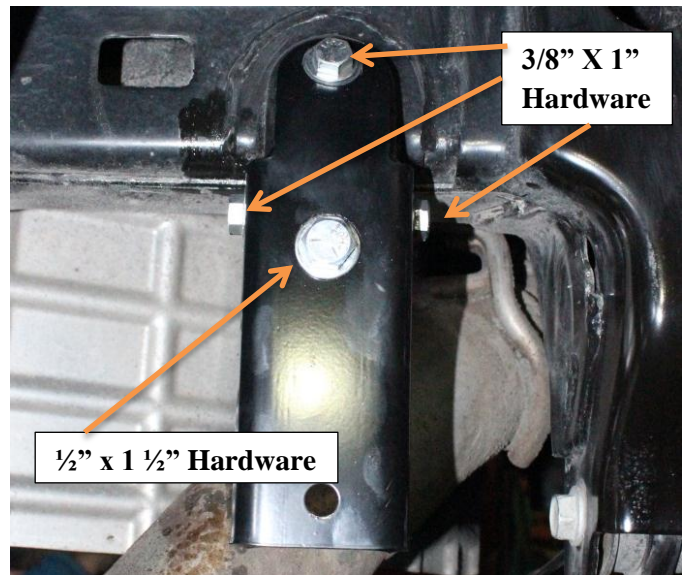

14) Enlarge the holes in the lower coil mounting plate to 7/16"

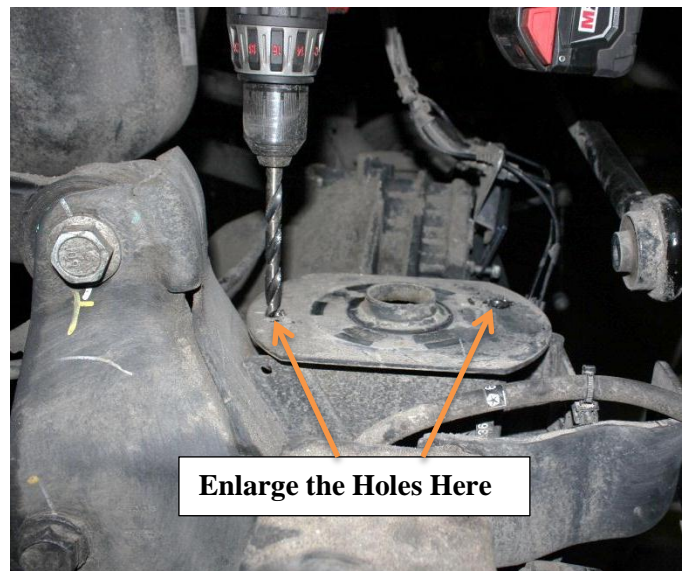

15) Install the track bar bracket using the supplied spacer as shown, Use the 5/8" x 4" hardware supplied, do not tighten at this time.

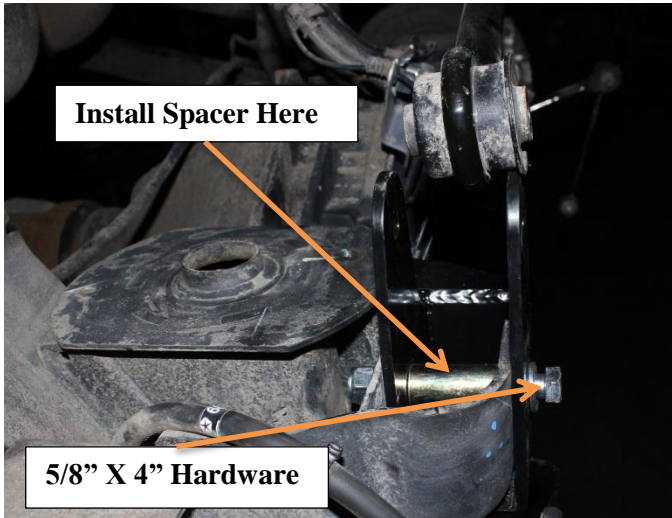

16) Install the supplied 7/16" hardware in the 2 lower holes as shown.

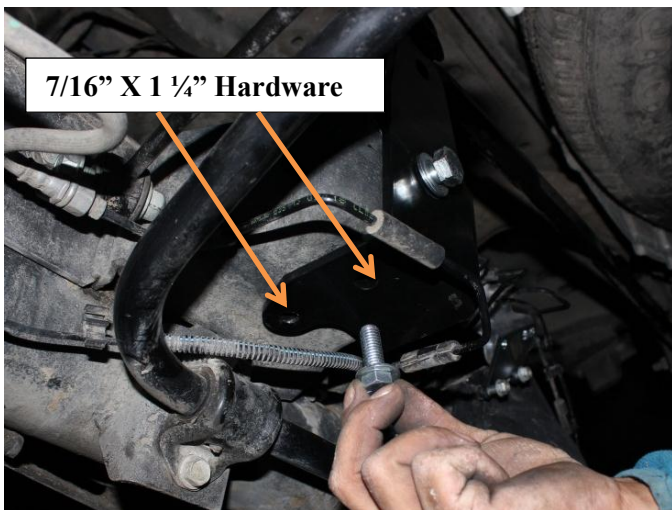

17) Install the DRIVER coil spacer using the 7/16" x 1 1/4" in the front hole and the 7/16" x 1 1/2" in the rear hole.

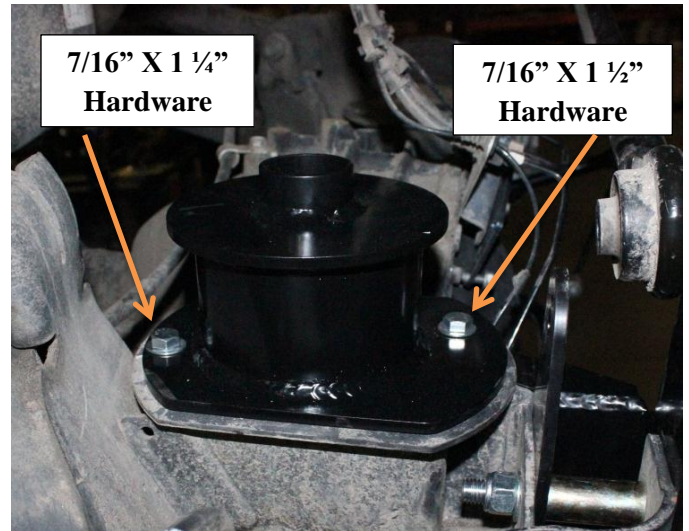

18) Tighten all the hardware attaching the track bar bracket and coil spacer to the axle.



19) Install the PASSENGER side coil spacer using the supplied 7/16" x 1 1/4" hardware as shown

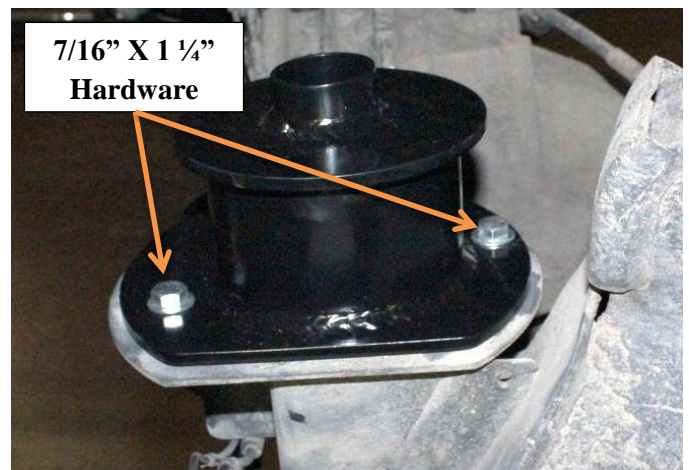

20) Install the rear coil springs.



21) Install the rear shock extender or shock at this time.



22) Reattach the rear sway bar end links to the drop bracket using the factory hardware.



23) Install the rear bump stop bracket as shown.

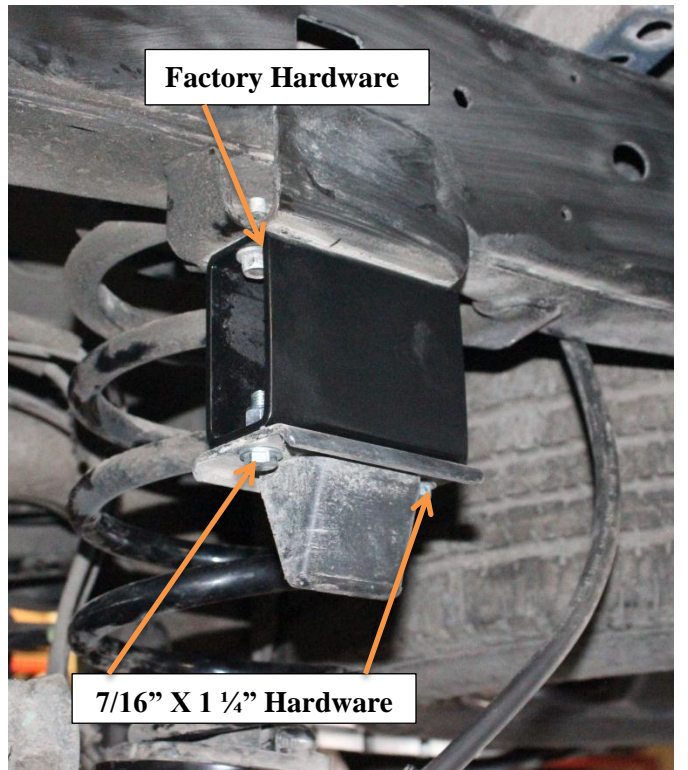



24) Install rear brake line bracket as shown.

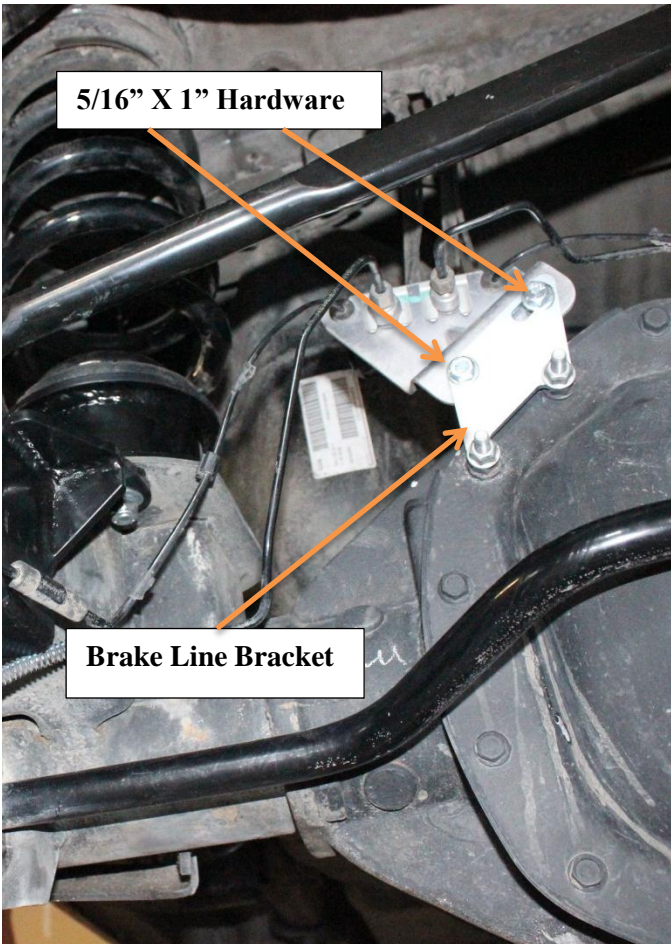



Product Warranty and Warnings-

FTS provides a Limited Lifetime Warranty to the original retail purchaser who owns the vehicle, on which the product was originally installed, for defects in workmanship and materials.

The Limited Lifetime Warranty excludes the following FTS items; bushings, bump stops, ball joints, tie rod ends, limiting straps, cross shafts, heim joints. These parts are subject to wear and are not considered defective when worn. They are warranted for 60 days from the date of purchase for defects in workmanship.

Reservoir shocks are considered a serviceable shock with a one year warranty on leakage only. Service seal kits are available separately for future maintenance. All other shocks are covered under our Limited Lifetime Warranty.

FTS does not warrant any product for finish, alterations, modifications and/or installation contrary to FTS instructions. Alterations to the finish of the parts including but not limited to painting, powder coating, plating and/or welding will void all warranties. Some finish damage may occur to parts during shipping which is considered normal and is not covered under warranty.

FTS products are not designed nor intended to be installed on vehicles used in race applications or for racing purposes or for similar activities. (A "RACE" is defined as any contest between two or more vehicles, or any contest of one or more vehicle against the clock, whether or not such contest is for a prize). This warranty does not include coverage for police or taxi vehicles, race vehicles, or vehicles used for government or commercial purposes. Also excluded from this warranty are sales outside of the United States of America.

Installation of most suspension products will raise the center of gravity of the vehicle and will cause the vehicle to handle differently than stock. It may increase the vehicle's susceptibility to a rollover, on road and off road, at all speeds. Extreme care should be taken to operate the vehicle safely at all times to prevent rollover or loss of control resulting in serious injury or death.

FTS makes every effort to ensure suspension product compatibility with all vehicles listed in the catalog, but due to unknown auto manufacturers production changes and/or inconsistencies by the auto manufacturer,

FTS cannot be responsible for 100% compatibility, including the fitment of tire and wheel sizes listed. The Tire and Wheel sizes listed in FTS's catalog are only a guideline for street driving with noted fender trimming. FTS is not responsible for damages to the vehicle's body or tires.

FTS's obligation under this warranty is limited to the repair or replacement, at FTS option, of the defective product only. All costs of removal, installation or re-installation, freight charges, incidental or consequential damages are expressly excluded from this warranty. FTS is not responsible for damages and/or warranty of other vehicle parts related or non-related to the installed FTS product. This warranty is expressly in lieu of all other warranties expressed or implied. This warranty shall not apply to any product that has been subject to accident, negligence, alteration, abuse or misuse as determined by FTS.

FTS suspension components must be installed as a complete system including shocks as shown on our current website. All warranties will become void if FTS parts are combined and/or substituted with other aftermarket suspension products. Combination and/or substitution of other aftermarket suspension parts may cause premature wear and/or product failure resulting in an accident causing injury or death. FTS does not warrant products not manufactured by FTS.

Installation of FTS product may void the vehicles factory warranty; it is the consumer's responsibility to check with their local vehicle's dealer for warranty disposition before the installation of the product.

It is the responsibility of the distributor and/or the retailer to review all warranties and warnings of FTS products with the consumer prior to purchase.

FTS reserves the right to supersede, discontinue, change the design, finish, part number and, or application of parts when deemed necessary without written notice. FTS is not responsible for misprints or typographical errors within the catalog or price sheet.

Thank You for choosing Full Throttle Suspension

Tech support 559-271-8685 or send email to fts.dwgs@gmail.com