

65844-2



2014-2015 DODGE 2500 4" REAR 5 LINK SUSPENSION



65844-2 Component Box 2

- 1) Track Bar Bracket
- 2) 2" Coil Spacers
- 1) 4" Left Sway Bar Drop Bracket
- 1) 4" Right Sway Bar Drop Bracket
- 2) 1.75" Rear Bump Stops

Hardware Bag 1

- 1) S2842 Sleeve .565 x 1.0 x 2.150 Sleeves
- 1) 9/16" x 4" Bolt
- 1) 9/16" Nylock Nut
- 2) 9/16" Washers
- 9) 7/16" x 1 1/4" Bolt
- 1) 7/16" x 1 1/2" Bolt
- 10) 7/16" Nylock Nut
- 20) 7/16" Washers
- 2) 1/2" x 1 1/2" Bolts
- 2) 1/2" Nylock Nuts
- 4) 1/2" Washers
- 6) 3/8" x 1" Bolts
- 6) 3/8" Nylock
- 12) 3/8" Washers
- 1) Brake Line Bracket
- 1) 5/16" x 1" Bolts
- 1) 5/16" Nylock Nuts
- 2) 5/16" Washers

REAR INSTRUCTIONS:

- 1) Jack up the rear end of the vehicle and support the frame.
- 2) Remove the rear wheels.
- 3) Support the rear axle with a hydraulic jack.
- 4) Disconnect the rear brake line bracket from the axle, retain all hardware.

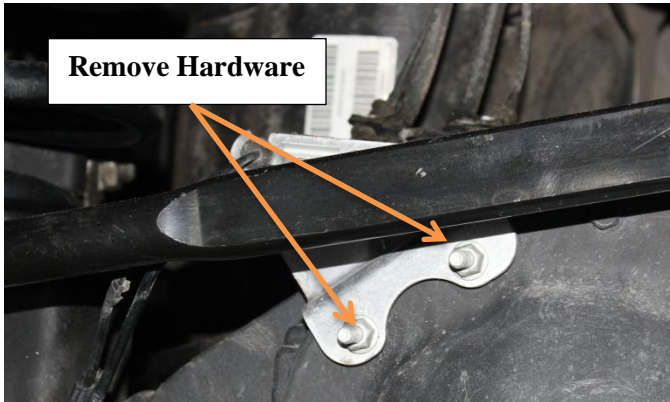

- 6) Disconnect the rear track bar from the axle, retain all hardware.



- 5) Disconnect the rear sway bar end links front the frame, retain all hardware.

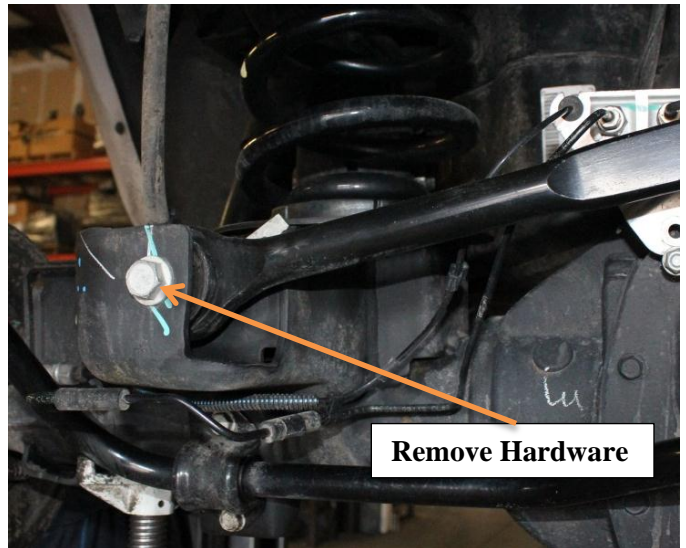

- 8) Disconnect the rear shocks lower shock hardware.

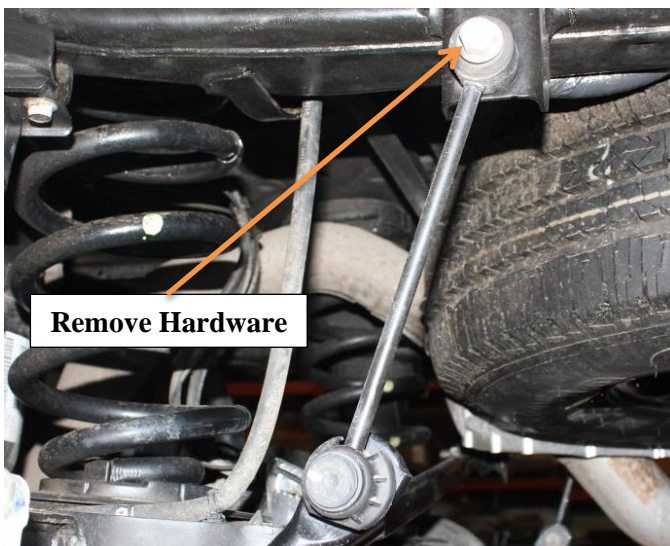

9) Disconnect the rear shocks upper shock hardware.

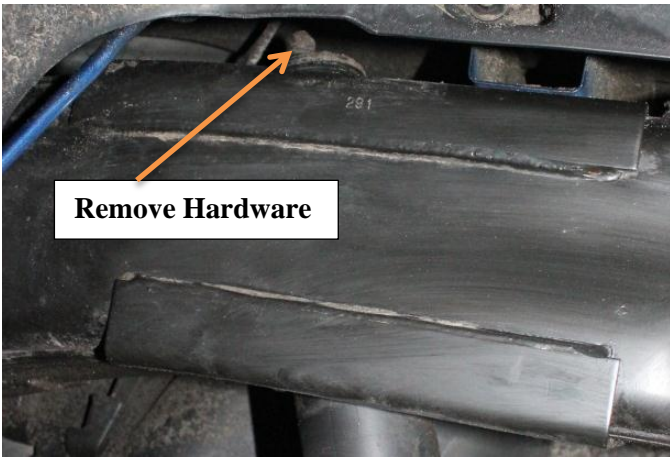

10) Lower the rear axle slowly, Remove the rear coil springs and upper and lower coil spring retainers.



11) Install the rear sway bar end link drop brackets using the supplied hardware.

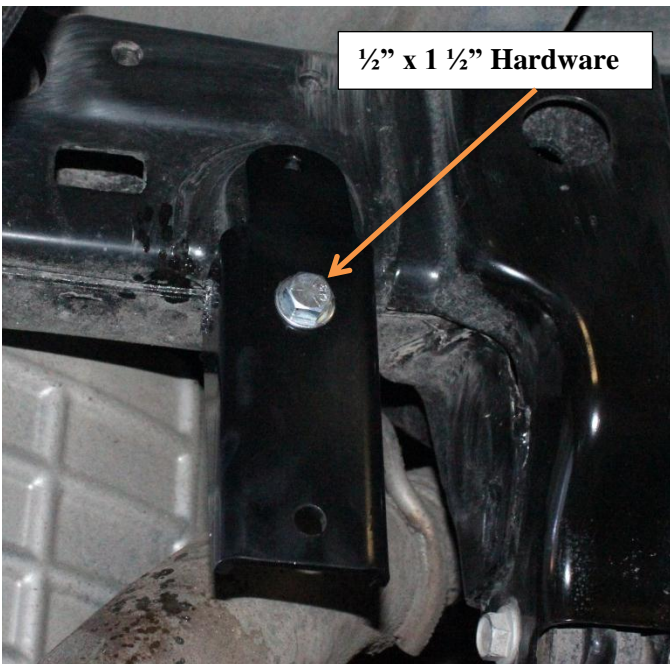

12) Drill the side hole in the frame 3/8". Use the sway bar drop bracket as the guide. Drill all the way through both sides.

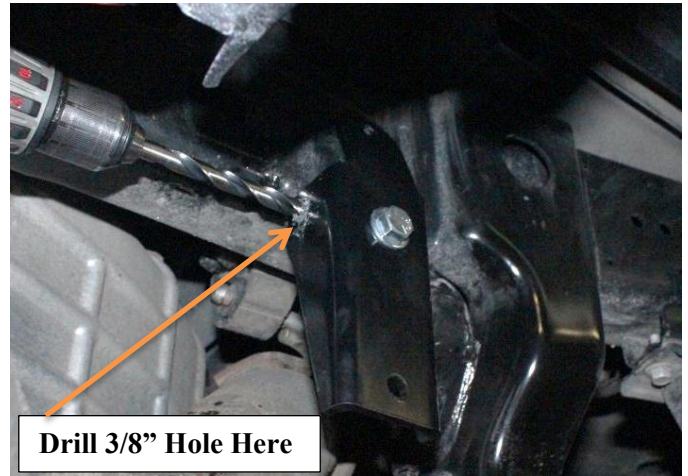

13) Install the 3/8 x 1" hardware as shown below.

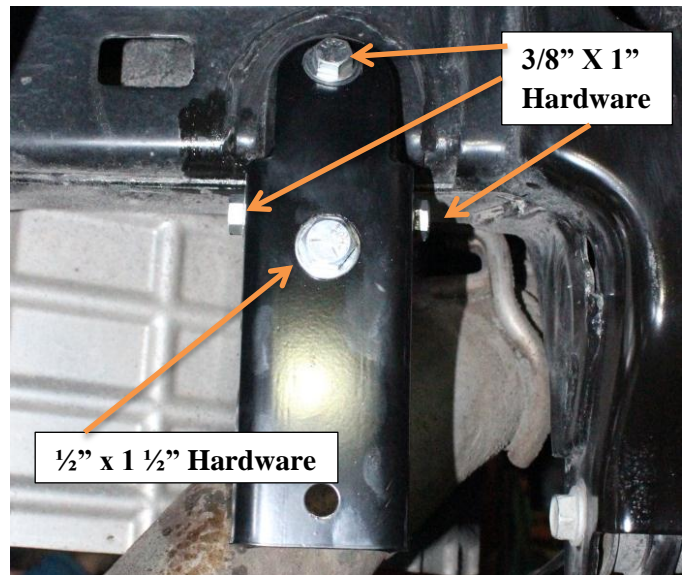

14) Enlarge the holes in the lower coil mounting plate to 7/16"

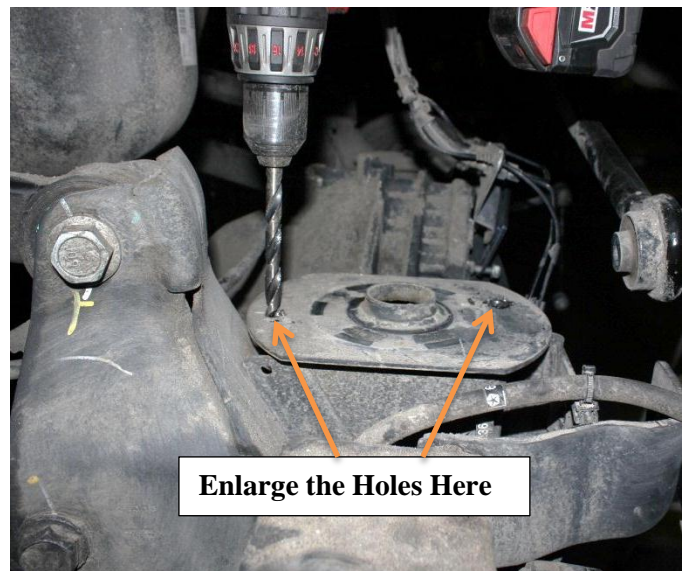

15) Install the track bar bracket using the supplied spacer as shown, Use the 9/16" x 4" hardware supplied, do not tighten at this time.

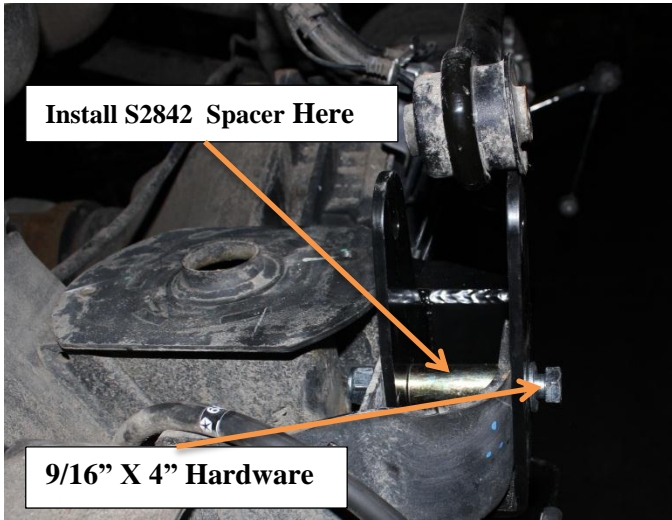

16) Install the supplied 7/16" hardware in the 2 lower holes as shown.

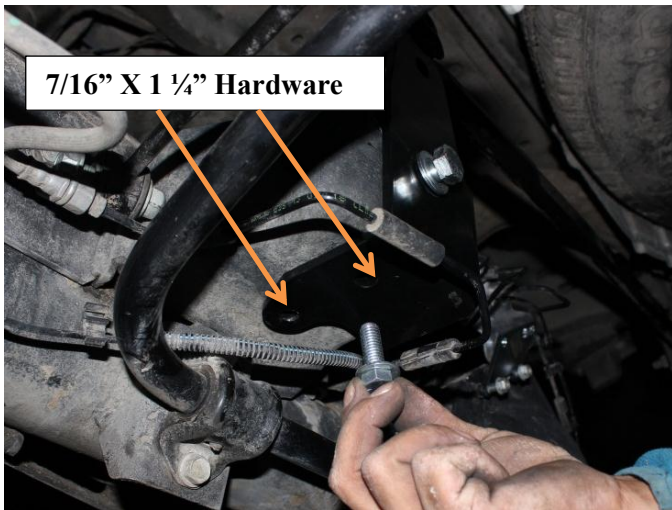

17) Install the DRIVER coil spacer using the 7/16" x 1 1/4" in the front hole and the 7/16" x 1 1/2" in the rear hole.

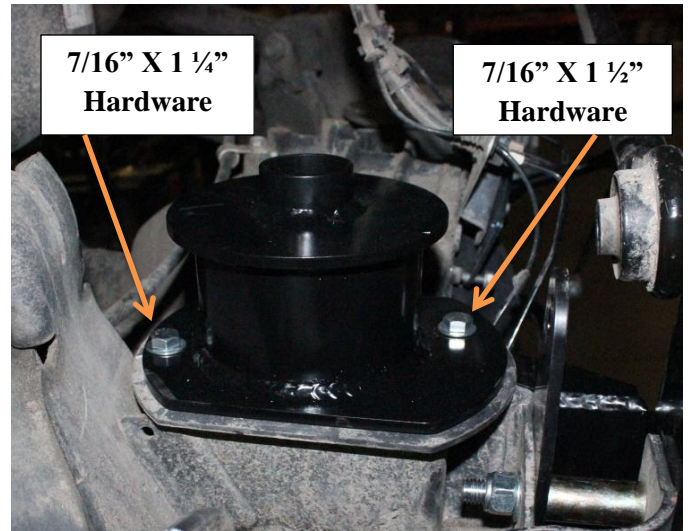

18) Tighten all the hardware attaching the track bar bracket and coil spacer to the axle.



19) Install the PASSENGER side coil spacer using the supplied 7/16" x 1 1/4" hardware as shown

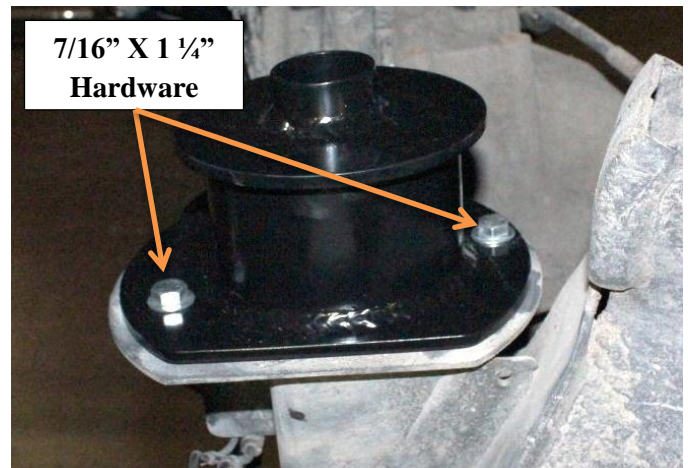

20) Install the rear coil springs.



21) Install the rear shock extender or shock at this time.



22) Reattach the rear sway bar end links to the drop bracket using the factory hardware.



23) Install the rear bump stop bracket as shown.

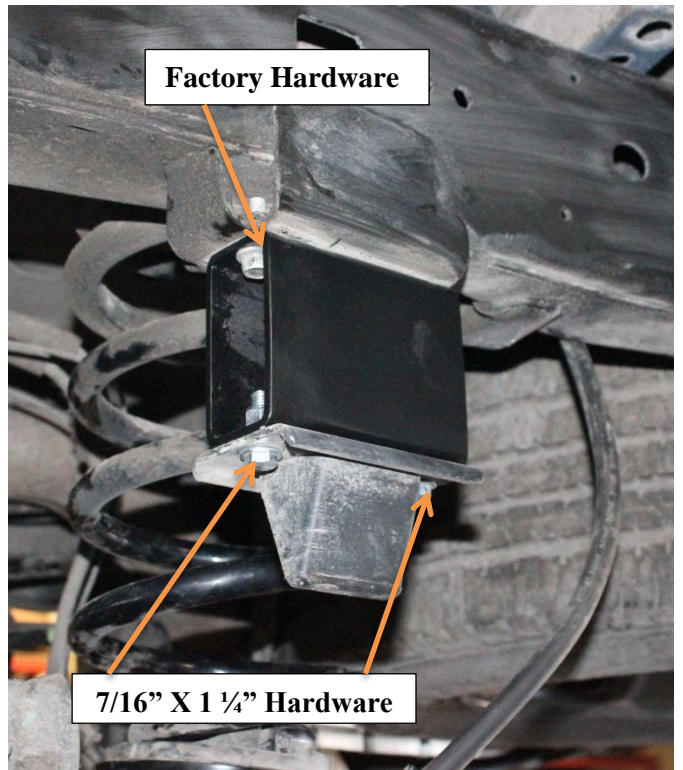



24) Install rear brake line bracket as shown.

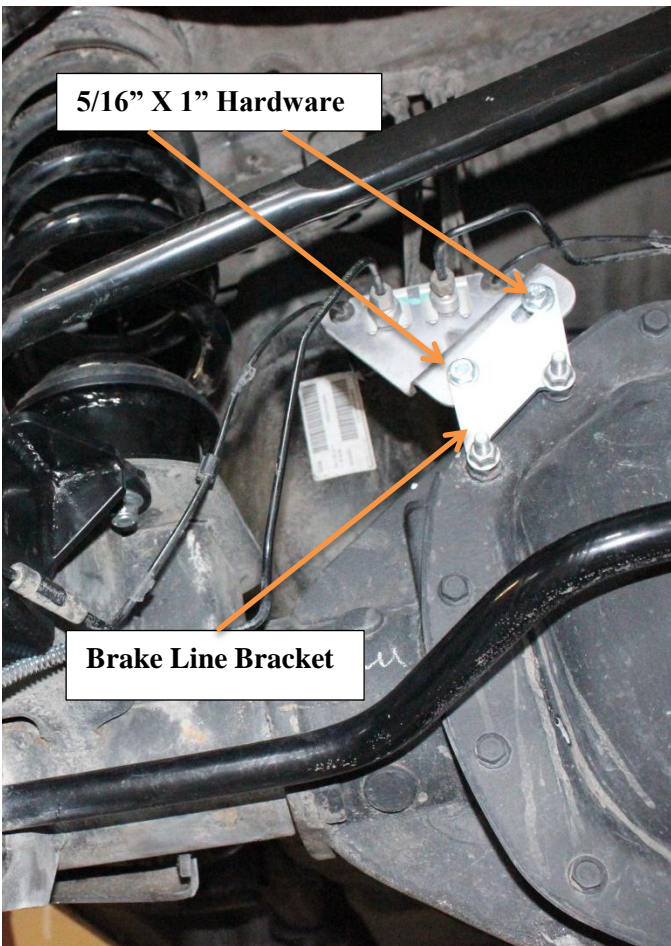



Product Warranty and Warnings-

FTS provides a Limited Lifetime Warranty to the original retail purchaser who owns the vehicle, on which the product was originally installed, for defects in workmanship and materials.

The Limited Lifetime Warranty excludes the following FTS items; bushings, bump stops, ball joints, tie rod ends, limiting straps, cross shafts, heim joints. These parts are subject to wear and are not considered defective when worn. They are warranted for 60 days from the date of purchase for defects in workmanship.

Reservoir shocks are considered a serviceable shock with a one year warranty on leakage only. Service seal kits are available separately for future maintenance. All other shocks are covered under our Limited Lifetime Warranty.

FTS does not warrant any product for finish, alterations, modifications and/or installation contrary to FTS instructions. Alterations to the finish of the parts including but not limited to painting, powder coating, plating and/or welding will void all warranties. Some finish damage may occur to parts during shipping which is considered normal and is not covered under warranty.

FTS products are not designed nor intended to be installed on vehicles used in race applications or for racing purposes or for similar activities. (A "RACE" is defined as any contest between two or more vehicles, or any contest of one or more vehicle against the clock, whether or not such contest is for a prize). This warranty does not include coverage for police or taxi vehicles, race vehicles, or vehicles used for government or commercial purposes. Also excluded from this warranty are sales outside of the United States of America.

Installation of most suspension products will raise the center of gravity of the vehicle and will cause the vehicle to handle differently than stock. It may increase the vehicle's susceptibility to a rollover, on road and off road, at all speeds. Extreme care should be taken to operate the vehicle safely at all times to prevent rollover or loss of control resulting in serious injury or death.

FTS makes every effort to ensure suspension product compatibility with all vehicles listed in the catalog, but due to unknown auto manufacturers production changes and/or inconsistencies by the auto manufacturer,

FTS cannot be responsible for 100% compatibility, including the fitment of tire and wheel sizes listed. The Tire and Wheel sizes listed in FTS's catalog are only a guideline for street driving with noted fender trimming. FTS is not responsible for damages to the vehicle's body or tires.

FTS's obligation under this warranty is limited to the repair or replacement, at FTS option, of the defective product only. All costs of removal, installation or re-installation, freight charges, incidental or consequential damages are expressly excluded from this warranty. FTS is not responsible for damages and/or warranty of other vehicle parts related or non-related to the installed FTS product. This warranty is expressly in lieu of all other warranties expressed or implied. This warranty shall not apply to any product that has been subject to accident, negligence, alteration, abuse or misuse as determined by FTS.

FTS suspension components must be installed as a complete system including shocks as shown on our current website. All warranties will become void if FTS parts are combined and/or substituted with other aftermarket suspension products. Combination and/or substitution of other aftermarket suspension parts may cause premature wear and/or product failure resulting in an accident causing injury or death. FTS does not warrant products not manufactured by FTS.

Installation of FTS product may void the vehicles factory warranty; it is the consumer's responsibility to check with their local vehicle's dealer for warranty disposition before the installation of the product.

It is the responsibility of the distributor and/or the retailer to review all warranties and warnings of FTS products with the consumer prior to purchase.

FTS reserves the right to supersede, discontinue, change the design, finish, part number and, or application of parts when deemed necessary without written notice. FTS is not responsible for misprints or typographical errors within the catalog or price sheet.

Thank You for choosing Full Throttle Suspension

Tech support 559-271-8685 or send email to fts.dwgs@gmail.com